

User Guide

INSIGNIA™

5 MP High Definition Digital Camcorder with 3.0" LCD Monitor

NS-DCC5HB09

Insignia NS-DCC5HB09

5 MP High Definition Digital Camcorder with 3.0" LCD Monitor

Contents

Introduction	2
Safety information	3
Features	3
Package contents	3
Front	3
Back	4
Side	4
Using the LCD	4
Setting up your camcorder	5
Installing the battery	5
Inserting or removing a memory card	5
Getting started	6
Turning on your camcorder	6
Taking a picture	6
Recording a movie	6
Recording sound	7
Working with movies	7
Selecting the resolution for movies	7
Using digital zoom	7
Selecting the exposure for movies	7
Using the built-in light	7
Using Night Mode for low-light movies	8
Adjusting the sharpness for movies	8
Adjusting the white balance for movies	9
Using motion stabilization for movies	9
Using motion detection to record movies	9
Selecting an effect for movies	10
Watching a movie	10
Deleting movies	10
Using movie thumbnails	11
Repeating movies	12
Locking or unlocking movies	12
Watching movies on a PC	13
Viewing pictures and movies on an HDTV	13
Viewing pictures or movies on a non-HDTV	13
Working with pictures	13
Taking close up pictures	13
Using digital zoom	14
Selecting the resolution for pictures	14
Selecting the exposure for pictures	14
Using Night Mode for low-light pictures	14
Adjusting the sharpness for pictures	15
Adjusting the white balance for pictures	15
Combining two pictures into one	16
Adding photo frames to pictures	16
Selecting the flash setting for pictures	17
Using the self-timer for pictures	17
Taking a sequence of pictures	17
Taking pictures with bright backgrounds	18
Adding the date to pictures	18
Selecting an effect for pictures	18
Viewing pictures	19
Deleting pictures	19
Using picture thumbnails	20
Locking or unlocking pictures	20
Viewing pictures in a slideshow	21
Working with voice recordings	21
Playing voice recordings	21
Deleting voice recordings	22
Repeating voice recordings	22
Transferring MP3s to your camcorder	23
Listening to MP3s	23
Repeating MP3s	23
Using an earphone	24
Configuring your camcorder	24
Default camcorder settings	24

Setting the time24
Displaying or hiding camcorder status information25
Turning sound effects on or off25
Formatting the built-in memory or a memory card25
Selecting the TV system type26
Selecting the on-screen menu language27
Restoring default settings27
Transferring files to a PC27
Maintaining27
Troubleshooting28
Specifications28
Installing the device driver software28
Accessing the User Guide28
One-Year Limited Warranty31

Introduction

Congratulations on your purchase of a high-quality Insignia product. Your NS-DCC5HB09 represents the state of the art in digital camcorder design and is designed for reliable and trouble-free performance.

Safety information

- Do not drop, puncture, or disassemble your camcorder. This voids your warranty.
- Avoid contact with water, and make sure that your hands are dry before using your camcorder.
- Do not expose your camcorder to high temperature or leave it in direct sunlight. High temperature or the heat from direct sunlight may damage your camcorder.
- For your protection, do not use your camcorder during a storm or when lightning is present.
- Do not use your camcorder while driving or riding a vehicle (such as a bicycle). An accident may occur.
- Do not use the flash close to eyes. Damage to vision may result.
- Keep your camcorder out the reach of small children or infants.
- Do not use the battery if it shows signs of leakage or distortion.
- Make sure that you replace the battery with one of the same type. Using a different type battery can lead to an explosion.
- Dispose of used batteries according to local hazardous waste regulations.

Features

- 5 mega-pixel sensor
- H.264 technology that compresses video to let you store more movies than traditional camcorders
- Up to 11 mega-pixel quality pictures
- Movie recording at an HD resolution of 1280 × 720
- HDMI port for connecting an HDTV
- AV OUT port for connecting a non-HDTV or earphone
- High-speed mini-USB 2.0 port for connecting a PC
- Automatic and manual exposure and color balance controls
- 8× digital zoom for enlarging pictures and movies
- Built-in memory that lets you store pictures and movies without using an SD memory card
- SD memory card slot that lets you increase storage capacity

Package contents

- Digital camcorder
- USB cable
- AV cable
- HDMI cable
- Adapter
- Lithium-ion rechargeable battery
- Quick Start Guide
- CD with device driver and User Guide
- Wrist strap
- Pouch

Front

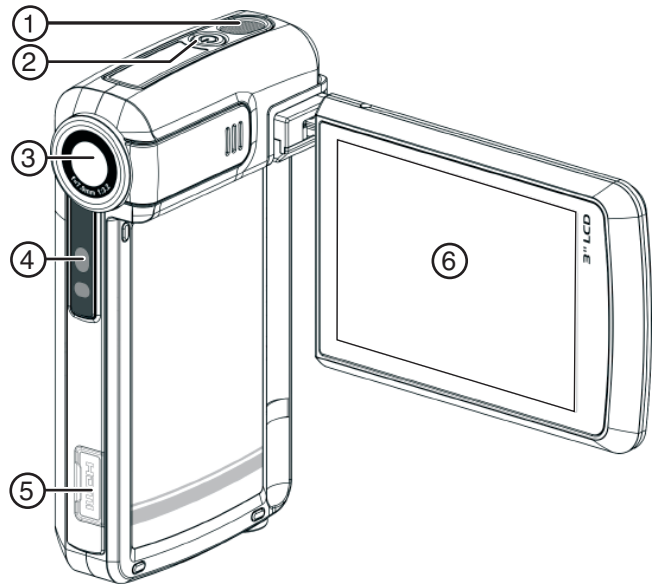

#	Component	Description
1	Microphone	Records sound as you record movies or records voice. For more information, see "Recording sound" on page 7.
2	Power  button	Press down for one second to turn your camcorder on or off.
3	Lens	Focuses the image when taking pictures or movies.
4	LED	Lights green when connected to a PC in PC camera mode. Lights red when connected to a PC in mass storage mode. Blinks during self-timer mode.
5	HDMI port	Connect an HDTV to this port so you can view your pictures and movies on the HDTV. For more information, see "Viewing pictures and movies on an HDTV" on page 13.
6	LCD panel	Lets you view pictures and movies while you are capturing them. Lets you view stored pictures and movies. Displays camcorder status information.

Back

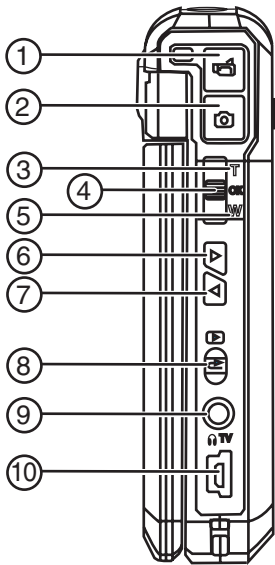

#	Component	Description
1	Movie shutter button	Press to record a movie. For more information, see "Recording a movie" on page 6.
2	Picture shutter button	Press to take a picture. For more information, see "Taking a picture" on page 6.
3	T (up) button	In record mode, press to zoom in. In menu mode, press to move up or to make selections.
4	OK button	Press to open the Record menu.
5	W (down) button	In record mode, press to zoom out. In menu mode, press to move down or to make selections.
6	▷ (right) button	Press to move right in menus or to make selections.
7	◁ (left) button	Press to move left in menus or to make selections.
8	Record/Play button	Press to toggle between Record mode and Playback mode. When a menu is open, press to close the menu and return to Record mode. In Playback mode, press to return to the previous page.
9	📶/TV port	Connect the earphone or a non-HDTV to this port. For more information, see "Viewing pictures or movies on a non-HDTV" on page 13 or "Using an earphone" on page 24.
10	Mini-USB 2.0 port	Connect the USB cable to this port and a USB port on a PC. For more information, see "Watching movies on a PC" on page 13.

Side

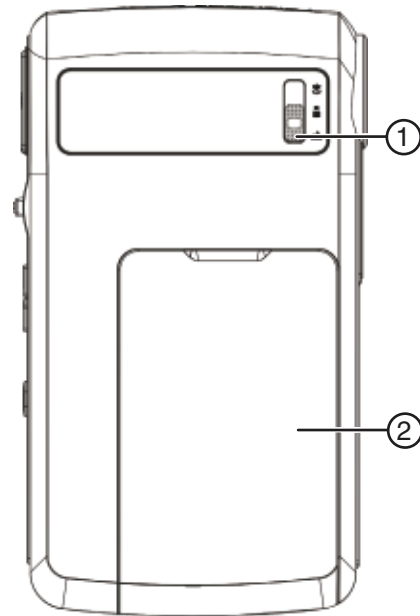

#	Component	Description
1	Macro switch	In record mode, press to select Macro mode, Portrait mode, or Normal mode. For more information, see "Taking close up pictures" on page 13.
2	Battery cover	Remove this cover to insert the battery or a memory card. For more information, see "Installing the battery" on page 5 or "Inserting or removing a memory card" on page 5.



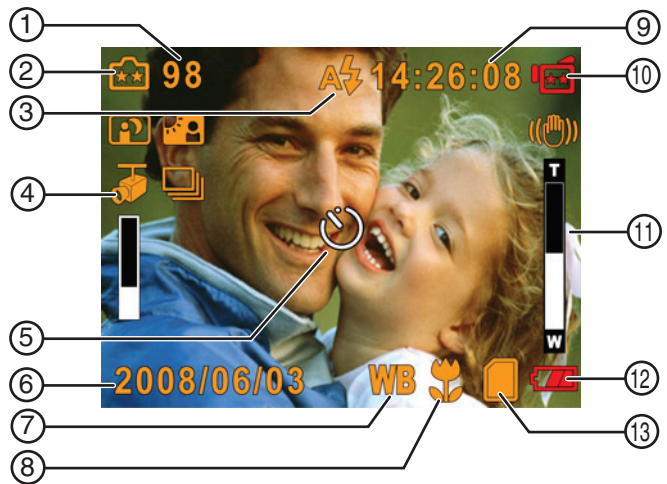

Using the LCD





















Record mode icons

	Movie Record mode
	Picture Record mode
	Voice Record mode
	Motion Stabilization mode
	Two-in-One mode

Record mode icons

	Photo Frame mode
	Multi-Snap mode
	Night mode
	Backlight mode

LCD icons

#	Icon
1	Number of images that can still be taken at the current resolution.
2	Picture resolution:  (high) /  (standard) /  (low)
3	A  (auto flash on)  (flash on)  (red-eye reduction on)  (light on)
4	 (motion detection on)
5	 (self-timer on)
6	Date and Time in YYYY/MM/DD HH:MM format
7	WB (white balance on)
8	 (macro mode on)
9	Recording time that can still be taken at the current resolution.
10	Movie resolution: Movie:  (HD) /  (D1) /  (VGA) /  (QVGA)
11	8× digital zoom
12	Battery indicator:  (battery charge full)  (medium charge)  (battery charge low)  (battery charge depleted)
13	 (memory card inserted)

Setting up your camcorder

Installing the battery

To install the battery:

- 1 Slide the battery cover off your camcorder.

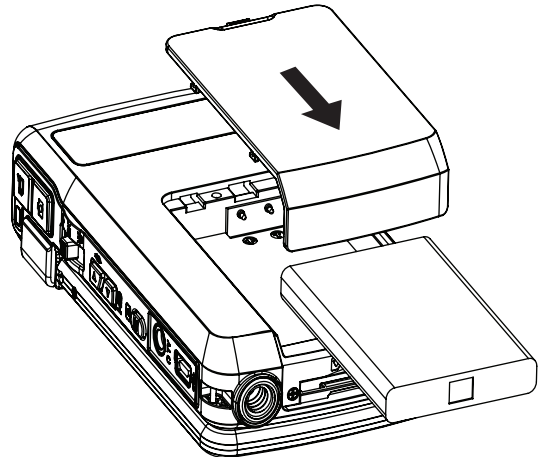

- 2 Insert the battery into the battery compartment. Make sure that the + and – symbols on the battery match the + and – symbols in the battery compartment.
- 3 Replace the battery cover.

Inserting or removing a memory card

Your camcorder has built-in memory for storing pictures and movies. You can increase the memory storage by using an SD memory card.

Note

When a memory card is inserted, your camcorder stores pictures and movies on the memory card instead of storing them in the built-in memory.

To insert or remove a memory card:

- 1 Slide the battery cover off of your camcorder.

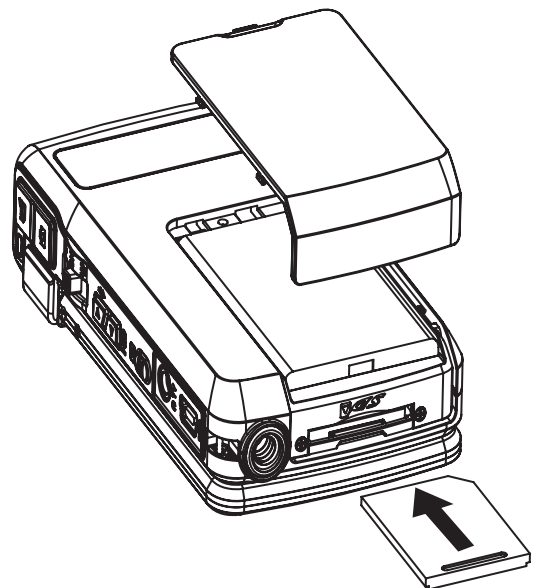

- 2 Insert an SD memory card into the memory card slot.
- 3 Replace the battery cover.

To remove a memory card:

- 1 Slide the battery cover off of your camcorder.
- 2 Push in on the memory card. The card pops out slightly.
- 3 Pull the card out of the slot.
- 4 Replace the battery cover.

Protecting an SD memory card

You can "protect" an SD memory card to prevent the recording or deletion of pictures or movies.

To protect an SD memory card:

- Slide the protection tab into the protected position.

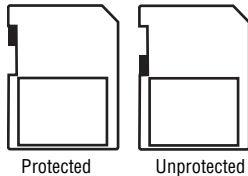

- 2 Rotate the LCD panel 90° counter-clockwise so you can view pictures and movies.

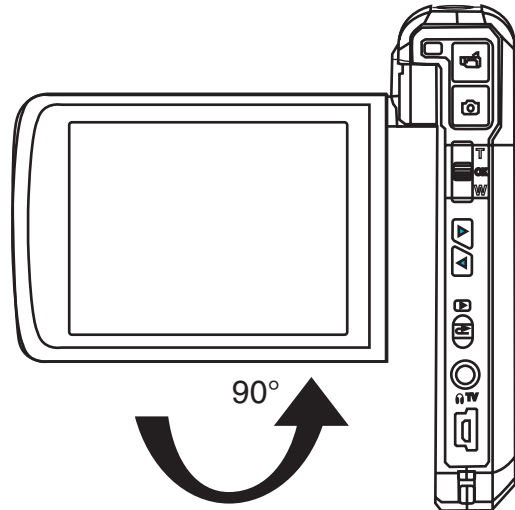

- 3 To turn off your camcorder, press down and hold  (Power) for one second.

Or

Return the LCD to its original (closed) position.

Getting started

Turning on your camcorder

To turn on your camcorder:

- 1 Press down and hold  (Power) for one second.

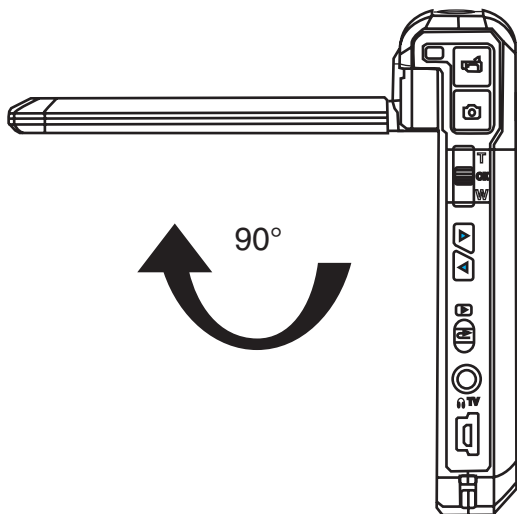

Or

Open the LCD panel 90°.







Taking a picture

To take a picture:

- 1 Turn on your camcorder.
- 2 Aim the camera lens, then press  (Picture Shutter).
- 3 Press  (Record/Play) once to view the picture.
- 4 Press  again to return to record mode.

Recording a movie

To record a movie:

- 1 Turn on your camcorder.
- 2 If you want to record the movie in HD resolution, press  to switch to HD mode.
- 3 Aim the camera lens, then press  (Movie Shutter).
- 4 Press  (Record/Play) once to stop recording.
- 5 Press  (Record/Play) again to view the movie.
- 6 Press  (Record/Play) again to return to record mode.

Recording sound

To record sound:

- 1 Press **OK** to open the record menu.



- 2 Press **◀** or **▶** to select **Voice Recording**.
- 3 Press **T** (up) or **W** (down) to select **OK**, then press **OK**.
- 4 Press **⏏** (Movie Shutter) to start recording.
- 5 Press **⏏** (Movie Shutter) again to stop recording.
- 6 Press **⏏** (Record/Play) to playback the recording.

Working with movies

Selecting the resolution for movies

You can record movies in any of four resolutions.

To select the resolution for movies:

- 1 Press **⏏** (Record/Play) to switch to record mode.
- 2 Press **OK**. The record menu opens.
- 3 Press **◀** or **▶** to select **Movie Mode**.



- 4 Press **T** (up) or **W** (down) to select **Resolution**, then press **OK**.



- 5 Press **T** (up) or **W** (down) to select **HD**, **D1**, **VGA**, or **QVGA**, then press **OK** to save your selection and close the menu. To exit without changing the resolution, select **Exit** or press **⏏** (Record/Play).

Using digital zoom

You can zoom on scenes to get close up when recording movies. The zoom selection are from 1× to 8×.

To use digital zoom:

- Press **T** to zoom in or press **W** to zoom out.

Selecting the exposure for movies

Your camcorder adjusts the image exposure automatically. You can manually adjust the exposure for special pictures.

To select the exposure for movies:

- 1 Press **⏏** (Record/Play) to switch to record mode.
- 2 Press **OK**. The record menu opens.
- 3 Press **◀** or **▶** to select **Movie Mode**.



- 4 Press **T** (up) or **W** (down) to select **Exposure**, then press **OK**.



- 5 Press **T** (up) or **W** (down) to select an exposure setting. The new exposure setting is previewed.
- 6 Press **OK** to save your selection and close the menu.

Using the built-in light

Your camcorder has a built-in light you can use to increase the light level in low-light settings.

To use the built-in light:

- 1 Press **⏏** (Record/Play) to switch to record mode.
- 2 Press **OK**. The record menu opens.

- 3 Press **◀** or **▶** to select **Movie Mode**.



- 4 Press **T** (up) or **W** (down) to select **Light**, then press **OK**.



- 5 Press **T** (up) or **W** (down) to select **on** or **off**, then press **OK** to save your selection and close the menu.

- 4 Press **T** (up) or **W** (down) to select **Night Mode**, then press **OK**.



- 5 Press **T** (up) or **W** (down) to select **On** or **Off**, then press **OK** to save your selection and close the menu.

Adjusting the sharpness for movies

You can use the sharpness to soften or sharpen images to achieve different effects.

To adjust the sharpness for movies:

- 1 Press **⏺** (Record/Play) to switch to record mode.
- 2 Press **OK**. The record menu opens.
- 3 Press **◀** or **▶** to select **Movie Mode**.



- 4 Press **T** (up) or **W** (down) to select **Sharpness**, then press **OK**.



- 5 Press **T** (up) or **W** (down) to select a sharpness level. The new sharpness setting is previewed.
- 6 Press **OK** to save your selection and close the menu.

Using Night Mode for low-light movies

The Night Mode option uses a longer exposure to capture more detail of the movie background.

To use Night Mode for low-light movies:



- 1 Press **⏺** (Record/Play) to switch to record mode.
- 2 Press **OK**. The record menu opens.
- 3 Press **◀** or **▶** to select **Movie Mode**.



Adjusting the white balance for movies

Your camcorder adjusts the color balance automatically. You can manually adjust the color balance for special movie effects.

To adjust the white balance for movies:

- 1 Press  (Record/Play) to switch to record mode.
- 2 Press **OK**. The record menu opens.
- 3 Press  or  to select **Movie Mode**.



- 4 Press **T** (up) or **W** (down) to select **Auto**, **Daylight**, **Fluorescent**, or **Tungsten**. The new white balance setting is previewed.



- 5 Press **OK** to save your selection and close the menu.

Using motion stabilization for movies



Motion stabilization increases stability and helps avoid blurry movies.

Notes

- The captured screen will be smaller when motion stabilization is turned on.
- Digital Zoom is disabled when motion stabilization is turned on.

To use motion stabilization for movies:

- 1 Press  (Record/Play) to switch to record mode.
- 2 Press **OK**. The record menu opens.

- 3 Press  or  to select **Movie Mode**.



- 4 Press **T** (up) or **W** (down) to select **Stabilization**, then press **OK**.





- 5 Press **T** (up) or **W** (down) to select **On** or **Off**, then press **OK** to save your selection and close the menu.

Using motion detection to record movies

When the Motion Detect option is turned on, your camcorder starts recording after it detects three seconds of motion (movement). It stops recording after three seconds of no motion.

To use motion detection to record movies:

- 1 Press  (Record/Play) to switch to record mode.
- 2 Press **OK**. The record menu opens.
- 3 Press  or  to select **Movie Mode**.



- Press **T** (up) or **W** (down) to select **Motion Detect**, then press **OK**.



- Press **T** (up) or **W** (down) to select **On** or **Off**, then press **OK** to save your selection and close the menu.

Selecting an effect for movies

You can select a visual effect for movies.

To select an effect for movies:

- Press  (Record/Play) to switch to record mode.
- Press **OK**. The record menu opens.
- Press **◀** or **▶** to select **Effect**.



- Press **T** (up) or **W** (down) to select **Normal**, **B/W** (black and white), **Classic**, or **Negative**. The new effect setting is previewed. To exit without selecting an effect, select **Exit**.
- Press **OK** to save your selection and close the menu.

Watching a movie



To watch a movie:

- Press  (Record/Play) to switch to playback mode.
- Press **◀** or **▶** to select **Movie**.



- Press **OK**.



- Press **◀** or **▶** to select the previous or next movie.
- Press  (Movie Shutter) to start playback. Press this button again to pause playback.
- To control movie playback:
 - Press and hold **◀** or **▶** to fast-reverse or fast-forward. Release the button to resume normal playback.
 - Press **T** (up) or **W** (down) to increase or decrease the volume.
- Press  (Movie Shutter) to stop playback.

Deleting movies

Note

If a memory card is in your camcorder, you can only delete movies on the card. To delete movies stored in built-in memory, remove the card. For instructions for removing a card, see "Inserting or removing a memory card" on page 5.

If a memory card is protected, you cannot delete movies from the card. For instructions for unprotecting a card, see "Protecting an SD memory card" on page 6.

You cannot delete a locked (protected) movie. You must unlock the movie. For instructions for unlocking a movie, see "Locking or unlocking movies" on page 12.

To delete a movie:

- Press  (Record/Play) to switch to playback mode.
- Press **◀** or **▶** to select **Movie**.



- Press **OK** twice to open the movie option menu.

- 4 Press ◀ or ▶ to select **Delete**.

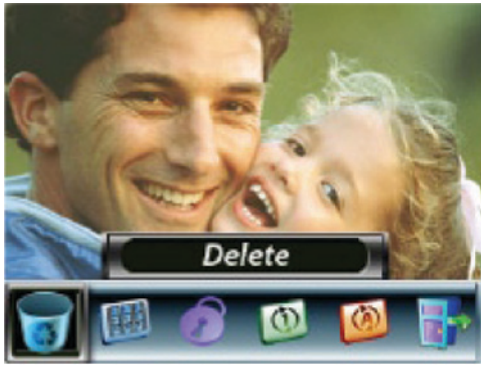

- 5 Press **OK** to open the delete menu.



- 6 Press ◀ or ▶ to select the movie you want to delete.
 7 Press **W** (down) to delete the movie. If you want to delete all movies, press **T** (up). A confirmation message appears.



- 8 Press **T** (up) or **W** (down) to select **Yes**. If you want to cancel the deletion, select **No**.
 9 Press **OK** to confirm your selection and close the menu.

Using movie thumbnails

To use movie thumbnails:

- 1 Press (Record/Play) to switch to playback mode.
- 2 Press ◀ or ▶ to select **Movie**.



- 3 Press **OK** twice to open the movie option menu.



- 4 Press ◀ or ▶ to select **Thumbnail**, then press **OK** to view the thumbnails.





- 5 To locate a movie, press ◀ or ▶ to select a thumbnail, then press **OK**.
- 6 To play the movie, press (Movie Shutter).



Locking or unlocking movies

You can lock movies to prevent them from being deleted.

To lock or unlock movies:

- 1 Press  (Record/Play) to switch to playback mode.
- 2 Press  or  to select **Movie**.





- 3 Press **OK** twice to open the movie option menu.
- 4 Press  or  to select **Lock**.



- 5 Press **OK** to open the lock menu.





- 6 Press  or  to select the movie you want to lock or unlock.
- 7 Press **W** (down) to lock or unlock the movie. If you want to lock or unlock all movies, press **T** (up). A confirmation message appears.
- 8 Press **T** (up) or **W** (down) to select **Yes**. If you want to cancel your selection, select **No**.
- 9 Press **OK** to confirm your selection and close the menu.



Repeating movies

You can play a single movie or all movies repeatedly.

To repeat movies:

- 1 Press  (Record/Play) to switch to playback mode.
- 2 Press  or  to select **Movie**.



- 3 Press **OK** twice to open the movie option menu.
- 4 Press  or  to select **Repeat One** or **Repeat All**.



- 5 Press **OK** to start repeat playback.

Watching movies on a PC

To watch movies on a PC:

- 1 Connect the mini-USB cable to the **USB** port on your camcorder, then connect the other end to a **USB** port on a PC.
- 2 Start the computer's video player, such as Windows Media Player.
- 3 Use the Windows Media Player controls to locate and play movies. Movies on a memory card are located at My Computer\Removable Disk\DCIM\200MOVIE.

Note

Your camcorder does not function when it is connected to a PC.

Viewing pictures and movies on an HDTV

To view pictures and movies on an HDTV:

- 1 Connect the HDMI cable to the **HDMI** port on your camcorder, then connect the other end of the cable to an **HDMI** port on a TV.

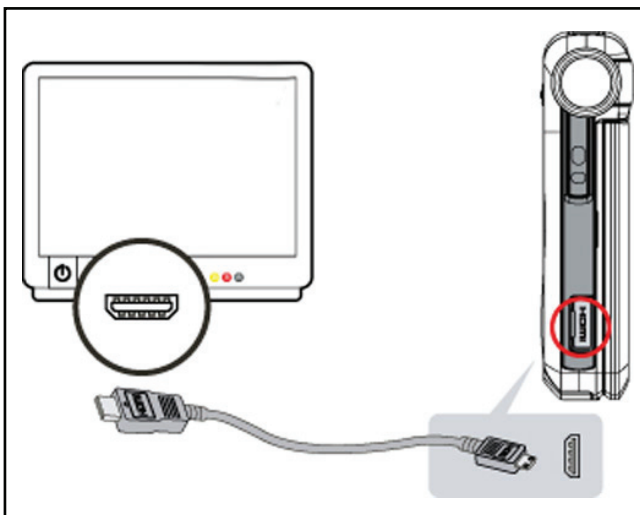

- 2 Set the video input on the TV to HDMI.
- 3 Follow the steps for playing movies or viewing pictures in "Watching a movie" on page 10 or "Viewing pictures" on page 19.

Viewing pictures or movies on a non-HDTV

You can view pictures or movies on a non-HDTV with a standard 4:3 aspect ratio or wide 16:9 aspect ratio.

Note

The LCD panel does not work when your camcorder is connected to a TV.

To view pictures or movies on a non-HDTV:

- 1 Connect one end of the AV cable to the **AV OUT** port on your camcorder, then connect the other end to the **AV IN** ports on the TV.

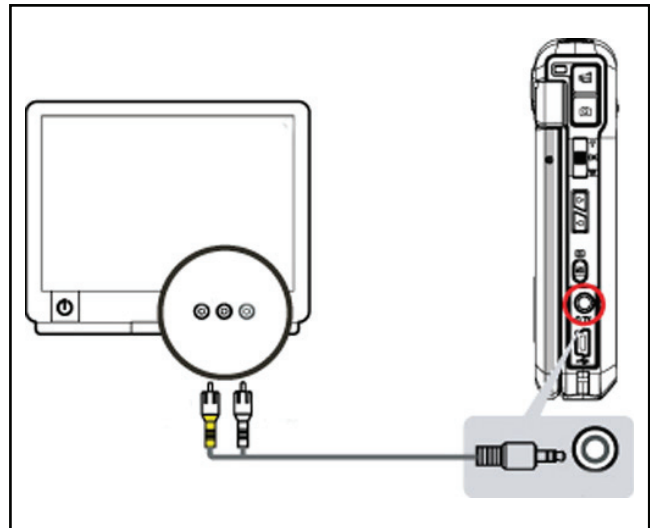

- 2 When the earphone/TV screen opens, press **T** (up) or **W** (down) to select **TV**.

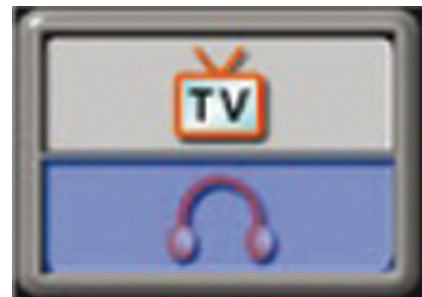

- 3 Set the video input on the TV to the correct input mode.
- 4 Follow the steps for playing movies or viewing pictures in "Watching a movie" on page 10 or "Viewing pictures" on page 19.

Working with pictures

Taking close up pictures

Your camcorder has two close-up picture modes for taking pictures at close range:

	<p>Macro mode Use this mode for objects located about 7.8 inches (20 cm) away. When Macro mode is active, the icon appears on the LCD.</p>
	<p>Portrait mode Use this mode for objects located about 35.4 to 78.7 inches (90 to 200 cm) away.</p>

To take close up pictures:

- 1 Slide the Macro switch to the Macro or Portrait position.
- 2 Press  (Picture Shutter) to take the picture.

Note

Make sure that you set the Macro switch to  (Normal) when you finish taking close-up pictures.

Using digital zoom

You can zoom on objects to get close up pictures. The zoom selections are from 1x to 8x.

To use digital zoom:

- Press **T** to zoom in or press **W** to zoom out.

Selecting the resolution for pictures

To select the resolution for pictures:

- 1 Press  (Record/Play) to switch to record mode.
- 2 Press **OK**. The record menu opens.
- 3 Press **<** or **>** to select **Camera Mode**.



- 4 Press **T** (up) or **W** (down) to select **Resolution**, then press **OK**.



- 5 Press **<** or **>** to select **High**, **Std** (standard), or **Low**, then press **OK** to save your selection and close the menu. To exit without changing the resolution, select **Exit** or press  (Record/Play).

Selecting the exposure for pictures

Your camcorder adjusts the image exposure automatically. You can manually adjust the exposure for special pictures.

To select the exposure for pictures:

- 1 Press  (Record/Play) to switch to record mode.
- 2 Press **OK**. The record menu opens.
- 3 Press **<** or **>** to select **Camera Mode**.



- 4 Press **T** (up) or **W** (down) to select **Exposure**, then press **OK**.



- 5 Press **T** (up) or **W** (down) to select an exposure setting. The new exposure setting is previewed.
- 6 Press **OK** to save your selection and close the menu.

Using Night Mode for low-light pictures

The Night Mode option uses a longer exposure to capture more detail of the picture background.

Note

To avoid blurry pictures, place the camera on a flat, steady surface or use a tripod.

To use Night Mode for low-light pictures:

- 1 Press  (Record/Play) to switch to record mode.
- 2 Press **OK**. The record menu opens.

3 Press **◀** or **▶** to select **Camera Mode**.



4 Press **T** (up) or **W** (down) to select **Night Mode**, then press **OK**.



5 Press **T** (up) or **W** (down) to select **On** or **Off**, then press **OK** to save your selection and close the menu.

Adjusting the sharpness for pictures

You can adjust the sharpness to soften or sharpen images to achieve different effects.

To adjust the sharpness for pictures:

- 1 Press **⏺** (Record/Play) to switch to record mode.
- 2 Press **OK**. The record menu opens.
- 3 Press **◀** or **▶** to select **Camera Mode**.



4 Press **T** (up) or **W** (down) to select **Sharpness**, then press **OK**.



- 5 Press **T** (up) or **W** (down) to select a sharpness level. The new sharpness setting is previewed.
- 6 Press **OK** to save your selection and close the menu.

Adjusting the white balance for pictures

Your camcorder adjusts the color balance automatically. You can manually adjust the color balance for special picture effects.

To adjust the white balance for pictures:

- 1 Press **⏺** (Record/Play) to switch to record mode.
- 2 Press **OK**. The record menu opens.
- 3 Press **◀** or **▶** to select **Camera Mode**.



4 Press **T** (up) or **W** (down) to select **Auto**, **Daylight**, **Fluorescent**, or **Tungsten**. The new white balance setting is previewed.



5 Press **OK** to save your selection and close the menu.

Combining two pictures into one

You can combine two pictures into one picture.

To combine two pictures into one:

- 1 Press  (Record/Play) to switch to record mode.
- 2 Press **OK**. The record menu opens.
- 3 Press **<** or **>** to select **Camera Mode**.



- 4 Press **T** (up) or **W** (down) to select **Two in One**, then press **OK**.



- 5 Press **T** (up) or **W** (down) to select **On**, then press **OK** to save your selection and close the menu.
- 6 Press  (Picture Shutter) to take the first picture.



- 7 Press  (Picture Shutter) to take the second picture.



- 8 Press  (Record/Play) to view the two-in-one picture.



Adding photo frames to pictures

- 1 Press  (Record/Play) to switch to record mode.
- 2 Press **OK**. The record menu opens.
- 3 Press **<** or **>** to select **Camera Mode**.



- 4 Press **T** (up) or **W** (down) to select **Photo Frame**, then press **OK**.



- 5 Press **T** (up) or **W** (down) to select a photo frame, then press **OK** to select **SET**.
- 6 Press **OK** to save your selection and close the menu.

Selecting the flash setting for pictures

Your camcorder has four flash settings. The flash setting icon appears on the LCD.

	Auto-flash —The flash fires automatically depending on the light conditions. Use this mode for general photography.
	On —The flash fires for every picture.
	Off —Use this mode when flash photography is prohibited or when the subject is beyond the range of the flash. When you turn off the flash, no flash icon appears on the LCD.
	Red-eye reduction —The flash fires twice right before you take the picture. Use this mode to help eliminate red reflection in eyes.

To select the flash setting for pictures:

- 1 Press (Record/Play) to switch to record mode.
- 2 Press **OK**. The record menu opens.
- 3 Press or to select **Camera Mode**.



- 4 Press **T** (up) or **W** (down) to select **Flash**, then press **OK**.



- 5 Press **T** (up) or **W** (down) to select a flash option, then press **OK** to save your selection and close the menu.

Note

You can also press to change the flash setting.

Note

The flash is disabled when the battery power is low

Using the self-timer for pictures

When the self-timer is turned on, your camcorder waits 10 seconds after you press (Picture Shutter) before it takes the picture.

To use the self-timer for pictures:

- 1 Press (Record/Play) to switch to record mode.
- 2 Press **OK**. The record menu opens.
- 3 Press or to select **Camera Mode**.



- 4 Press **T** (up) or **W** (down) to select **Selftimer**, then press **OK**.



- 5 Press **T** (up) or **W** (down) to select **On** or **Off**, then press **OK** to save your selection and close the menu.

Taking a sequence of pictures

When the Multi-snap option is turned on, your camcorder takes five pictures in rapid sequence.

To take a sequence of pictures:

- 1 Press (Record/Play) to switch to record mode.
- 2 Press **OK**. The record menu opens.
- 3 Press or to select **Camera Mode**.



- Press **T** (up) or **W** (down) to select **Multi-snap**, then press **OK**.



- Press **T** (up) or **W** (down) to select **On** or **Off**, then press **OK** to save your selection and close the menu.

Taking pictures with bright backgrounds

When the Backlight option is turned on, you improve the foreground clarity of pictures when the background is bright.

To take pictures with bright backgrounds:

- Press **(Record/Play)** to switch to record mode.
- Press **OK**. The record menu opens.
- Press **◀** or **▶** to select **Camera Mode**.



- Press **T** (up) or **W** (down) to select **Backlight**, then press **OK**.



- Press **T** (up) or **W** (down) to select **On** or **Off**, then press **OK** to save your selection and close the menu.

Adding the date to pictures

When the Date Printing option is turned on, your camcorder adds the date to each picture you take. The date appears on pictures when you print them.

- Press **(Record/Play)** to switch to record mode.
- Press **OK**. The record menu opens.
- Press **◀** or **▶** to select **Camera Mode**.



- Press **T** (up) or **W** (down) to select **Date Printing**, then press **OK**.



- Press **T** (up) or **W** (down) to select **On** or **Off**, then press **OK** to save your selection and close the menu.

Selecting an effect for pictures

You can select a visual effect for pictures.

To select an effect for pictures:

- Press **(Record/Play)** to switch to movie/picture record mode.
- Press **OK**. The record menu opens.

- 3 Press \triangleleft or \triangleright to select **Effect**.



- 4 Press **T** (up) or **W** (down) to select **Normal**, **B/W** (black and white), **Classic**, or **Negative**. The new effect setting is previewed. To exit without selecting an effect, select **Exit**.
- 5 Press **OK** to save your selection and close the menu.

Viewing pictures

To view pictures:

- 1 Press \square (Record/Play) to switch to playback mode.
- 2 Press \triangleleft or \triangleright to select **Picture**.



- 3 Press **OK**.



- 4 Press \triangleleft or \triangleright to select the previous or next picture.
- 5 To control picture playback:
 - Press **T** (up) or **W** (down) to enlarge the picture.
 - To navigate around the enlarged picture, press **OK** to enter navigation mode, then press \triangleleft , \triangleright , **T** (up), or **W** (down). To exit navigation mode, press **OK** again.

Deleting pictures

Note

If a memory card is in your camcorder, you can only delete pictures on the card. To delete pictures stored in built-in memory, remove the card. For instructions for removing a card, see "Inserting or removing a memory card" on page 5.

If a memory card is protected, you cannot delete pictures from the card. For instructions for unprotecting a card, see "Protecting an SD memory card" on page 6.

You cannot delete a locked (protected) picture. You must unlock the picture. For instructions for unlocking a picture, see "Locking or unlocking pictures" on page 20.

To delete pictures:

- 1 Press \square (Record/Play) to switch to playback mode.
- 2 Press \triangleleft or \triangleright to select **Picture**.



- 3 Press **OK** twice to open the picture option menu.



- 4 Press \triangleleft or \triangleright to select **Delete**, then press **OK**.



- 5 Press \triangleleft or \triangleright to select the picture you want to delete.

- Press **W** (down) to delete the picture. If you want to delete all pictures, press **T** (up). A confirmation message appears.



- Press **T** (up) or **W** (down) to select **Yes**. If you want to cancel the deletion, select **No**.
- Press **OK** to complete the deletion.

Using picture thumbnails

To use movie thumbnails:

- Press **⏮** (Record/Play) to switch to playback mode.
- Press **◀** or **▶** to select **Picture**.



- Press **OK** twice to open the picture option menu.



- Press **◀** or **▶** to select **Thumbnail**.

- Press **OK** to view the thumbnails.



- To view a picture, press **◀** or **▶** to select its thumbnail, then press **OK**.

Locking or unlocking pictures

You can lock movies to prevent them from being deleted.

To lock or unlock pictures:

- Press **⏮** (Record/Play) to switch to playback mode.
- Press **◀** or **▶** to select **Picture**.



- Press **OK** twice to open the picture option menu.
- Press **◀** or **▶** to select **Lock**.



- 5 Press **OK** to open the lock menu.



- 6 Press **◀** or **▶** to select the picture you want to lock or unlock.
- 7 Press **W** (down) to lock or unlock the picture. If you want to lock or unlock all movies, press **T** (up). A confirmation message appears.
- 8 Press **T** (up) or **W** (down) to select **Yes**. If you want to cancel your selection, select **No**.
- 9 Press **OK** to confirm your selection and close the menu.

Viewing pictures in a slideshow

To view pictures in a slideshow:

- 1 Press **⏺** (Record/Play) to switch to playback mode.
- 2 Press **◀** or **▶** to select **Picture**.



- 3 Press **OK** twice to open the picture option menu.
- 4 Press **◀** or **▶** to select **Slideshow**.



- 5 Press **OK** to start the slideshow. Press **OK** again to stop the slideshow.

Working with voice recordings

Playing voice recordings

To play voice recordings:

- 1 Press **⏺** (Record/Play) to switch to playback mode.
- 2 Press **◀** or **▶** to select **Voice**.





- 3 Press **OK** to go to voice playback mode.



- 4 Press **◀** or **▶** to go to the previous or next voice recording.
- 5 Press **⏺** (Movie Shutter) to play the recording. Press this button again to stop playback.
- 6 Press **T** (up) or **W** (down) to adjust the volume.

Deleting voice recordings



To delete voice recordings:

- 1 Press  (Record/Play) to switch to playback mode.
- 2 Press  or  to select **Voice**.



- 3 Press **OK** to go to voice playback mode.





- 4 Press  or  to select the recording you want to delete.
- 5 Press **OK** to open the voice option menu.



- 6 Press **T** (up) to select the delete option.
- 7 Press **W** (down) to delete the recording you selected or press **T** (up) to delete all recordings. A confirmation message appears.
- 8 Press **T** (up) or **W** (down) to select **Yes**. If you want to cancel the deletion, select **No**.
- 9 Press **OK** to close the menu.

Repeating voice recordings



To repeat voice recordings:

- 1 Press  (Record/Play) to switch to playback mode.
- 2 Press  or  to select **Voice**.



- 3 Press **OK** to go to voice playback mode.



- 4 Press  or  to select the recording you want to repeat.
- 5 Press **OK** to open the voice option menu.



- 6 Press **W** (down) once to repeat the recording you selected or press **W** (down) twice to repeat all recordings.
- 7 To cancel repeat play, press **W** (down) again.
- 8 Press **OK** to save your selection and go back to the playback menu.

Transferring MP3s to your camcorder

To transfer MP3s to your camcorder:

- 1 Connect the mini-USB cable to the **USB** port on your camcorder, then connect the other end to a **USB** port on a PC. The red LED lights when your camcorder is connected to the PC, and your camcorder is in Mass Storage mode.
- 2 Make sure that you have a memory card with enough memory inserted into your camcorder.
- 3 Open **My Computer**, click and drag the MP3s you want to transfer to the **Removable Disk\DCIM** drive icon.
- 4 After you transfer all MP3s, disconnect the USB cable from the PC.

Listening to MP3s

To listen to MP3s:

- 1 In playback mode, press ◀ or ▶ to select **Music**.



- 2 Press **OK**, then press **T** (up) or **W** (down) to select the MP3 you want to listen to or press ◀ or ▶ to go to the previous or next page in the list of MP3s.



- 3 Press **Movie Shutter** or **OK** to start playback. Press this button again to stop playback.
- 4 Press **T** (up) or **W** (down) to adjust the volume.

Repeating MP3s

To repeat MP3s:

- 1 In playback mode, press ◀ or ▶ to select **Music**.



- 2 Press **OK**, then press **T** (up) or **W** (down) to select the MP3 you want to listen to or press ◀ or ▶ to go to the previous or next page in the list of MP3s.



- 3 Press **OK** twice to go to the repeat menu.

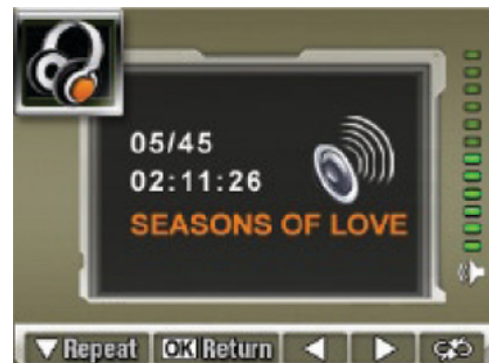

- 4 Press **W** (down) once to repeat the selected MP3. Press **W** (down) again to repeat all MP3s.
- 5 To cancel repeat play, press **W** (down) again.
- 6 Press **OK** to save your selection.

Using an earphone

You can use an earphone to listen to MP3s.

To use an earphone:

- 1 Plug an earphone into the earphone jack on your camcorder. A menu pops up.
- 2 When the earphone/TV menu opens, press **T** or **W** to select .

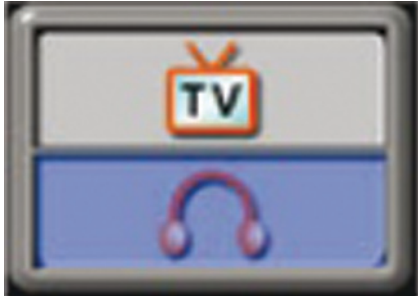

- 3 Press **OK** to close the menu.

Configuring your camcorder

Default camcorder settings

The following table list the default settings for your camcorder.

Always means the setting is always valid (on).

One Time means the setting is only valid (on) for one picture or movie or until you turn off your camcorder.

Setting	Valid	Default Setting
Resolution	Always	VGA for movies Standard for pictures.
Exposure	One Time	0EV
Light	One Time	Off
Sharpness	One Time	Level 5
White Balance	One Time	Auto
Motion Stabilization	Always	Off
Motion Detect	One Time	Off
Two in One	One Time	Off
Photo Frame	One Time	Off
Flash	Always	Off
Self-Timer	One Time	Off
Multi-Snap	One Time	Off
Backlight Mode	One Time	Off
Date Printing	Always	Off
Nite Mode	Always	Off
Effect	One Time	Normal
Sound	Always	On
Format Card	One Time	Off
TV System	Always	Depends on the shipping area
Language	Always	Depends on the shipping area
Volume	Always	Level 8

Setting the time

To set the time:

- 1 In record mode, press **OK** to open the record menu.
- 2 Press **◀** or **▶** to select **Setting**. The *Setting* menu opens.



- 3 Press **T** (up) or **W** (down) to select **Time Setting**, then press **OK**. The *Time Setting* screen opens.



- 4 Press **◀** or **▶** to move between **Date** and **Time**.
- 5 Press **T** (up) or **W** (down) to change the **Date** or **Time**.
- 6 Press **◀** or **▶** to select **Set**, then press **OK** to save your setting and close the menu.
Or
Press **◀** or **▶** to select **Exit**, then press **OK** to close the menu without saving your setting.

Displaying or hiding camcorder status information

To display or hide camcorder status information:

- 1 In record mode, press **OK** to open the record menu.
- 2 Press **◀** or **▶** to select **Setting**. The *Setting* menu opens.



- 3 Press **T** (up) or **W** (down) to select **Display**, then press **OK**. The *Display* menu opens.



- 4 Press **T** (up) or **W** (down) to select **On** if you want the indicators to appear on the LCD or **Off** if you do not want the indicators to appear on the LCD.
- 5 Press **OK** to save your setting and close the menu.

Turning sound effects on or off

Your camcorder plays a tone when you press a button. You can turn sound effects on or off.

To turn sound effects on or off:

- 1 In record mode, press **OK** to open the record menu.
- 2 Press **◀** or **▶** to select **Setting**. The *Setting* menu opens.



- 3 Press **T** (up) or **W** (down) to select **Sound**, then press **OK**. The sound setting menu opens.



- 4 Press **T** or **W** to select **On** or **Off**, then press **OK** to save your selection and close the menu.

Formatting the built-in memory or a memory card

When a memory card is inserted, you can format the card. When a memory card is not inserted, you can format the built-in memory.

To format a memory card:

To format the built-in memory or a memory card:

- 1 If you want to format the built-in memory, make sure that a memory card is not inserted in your camcorder.

Or

If you want to format a memory card, insert the memory card into your camcorder.

- 2 In record mode, press **OK** to open the record menu.

- 3 Press **◀** or **▶** to select **Setting**. The *Setting* menu opens.



Or



- 4 Press **T** (up) or **W** (down) to select **Format Memory** or **Format Card**. The format memory or format card menu opens.



- 5 Press **T** (up) or **W** (down) to select **On** or **Off**, then press **OK** to save your selection and close the menu.

Caution

Formatting a memory card will permanently delete all files from the card. Make sure that you copy any files you want to save to a computer before you format the card.
Do not remove the memory card while it is formatting.

Selecting the TV system type

When you connect a TV, make sure that the correct TV system type is selected. If you select the wrong TV system type, the image may flicker.

NTSC is the system type for U.S.A., Canada, and Mexico.

To select the TV system type:

- 1 In record mode, press **OK** to open the record menu.
- 2 Press **◀** or **▶** to select **Setting**. The *Setting* menu opens.



- 3 Press **T** (up) or **W** (down) to select **TV System**. The *TV System* menu opens.



- 4 Press **T** (up) or **W** (down) to select your TV system type, then press **OK** to save your setting and close the menu.
- 5 Press **T** (up) or **W** (down) to select **Exit**, then press **OK** to close the menu.

Selecting the on-screen menu language

To select the on-screen menu language:

- 1 In record mode, press **OK** to open the record menu.
- 2 Press **◀** or **▶** to select **Setting**. The *Setting* menu opens.



- 3 Press **T** (up) or **W** (down) to select **Language**. The *Language* menu opens.



- 4 Press **T** (up) or **W** (down) to select a language, then press **OK** to save your selection and close the menu.

Restoring default settings

To restore default settings:

- 1 In record mode, press **OK** to open the record menu.
- 2 Press **◀** or **▶** to select **Setting**. The *Setting* menu opens.



- 3 Press **T** (up) or **W** (down) to select **Default Setting**. The *Default Setting* menu opens.



- 4 Press **T** (up) or **W** (down) to select **Yes**. If you want to cancel the restoration, select **No**.
- 5 Press **OK** to restore settings and close the menu.

Transferring files to a PC

The PC you connect your camcorder to must meet the following requirements:

- Windows Vista®, Windows® XP, Windows® 2000, Windows® Me, or Windows® 98SE operating system
- Pentium® III processor with 800 MHz or above
- 256 MB of memory
- CD drive
- 1 GB free hard drive space
- Available USB 2.0 port

To transfer files to a PC:

- 1 Connect the mini-USB cable to the **USB** port on your camcorder, then connect the other end to a **USB** port on a PC. The red LED lights when your camcorder is connected to the PC, and your camcorder is in Mass Storage mode.
- 2 Open **My Computer**, then double-click **Removable Disk\DCIM**. The files on your camcorder are displayed. From My Computer, you can read, delete, move, and copy any movies, pictures, or voice recordings on your camcorder.

Maintaining

- Avoid pressing hard on the camcorder body.
- Do not subject the LCD to impact because the glass may break and fluid may leak from your camcorder.
- When you store your camcorder for an extended period or you are not going to use it soon, remove the batteries. Leakage may occur that will damage your camcorder.

Troubleshooting

Problem	Solution
The image on the LCD is not clear.	Try switching between Macro mode, Portrait mode, or Normal mode to adjust the focus. Use Macro mode for objects within 7.8 inches. Use Normal for objects over 7.8 inches away.
Picture not recording correctly.	To record, adjust the focus, then press the shutter button. A "funnel" icon appears in the center of the LCD. Hold your camcorder steady until the "funnel" disappears.
The flash is not working.	Make sure that your camcorder is not in Macro mode. Make sure that the batteries are not low.
When recording, zoom does not work.	Make sure that the stabilization feature is turned off. For more information, see "Using motion stabilization for movies" on page 9.
Files on a memory card do not display correctly when "!" or the "funnel" icon appear on the LCD.	The "!" indicates that the file format is not supported by your camcorder. The "funnel" icon indicates that the file cannot be displayed correctly. Delete the files with incorrect file formats. We recommend that you format the memory card before you use it, and avoid placing files with different formats in the same folder.

Image Resolution	<ul style="list-style-type: none"> • 3744 × 2808 (11M pixels) • 2592 × 1944 (5M pixels) • 1600 × 1200 (2M pixels)
Movie Resolution	<ul style="list-style-type: none"> • HD: 1280 × 720 pixels 30 fps • D1: 720 × 480 pixels 30 fps • VGA: 640 × 480 pixels 30 fps • QVGA: 320 × 240 pixels 30 fps
White Balance	Auto and Manual (Daylight, Fluorescent, and Tungsten)
Exposure	Auto and Manual
Self-Timer	10 second delay
Flash	<ul style="list-style-type: none"> • Auto • On • Off • Red Eye Reduction • Light: On or Off
File Format	<ul style="list-style-type: none"> • Picture: JPEG • Movie: AVI (Xvid) • Voice: WAV • Music: MP3
Image play	<ul style="list-style-type: none"> • Single Image • Thumbnails • Slideshow
PC Interface	Mini USB 2.0 Port
TV out	NTSC and PAL selectable
Battery	Lithium-ion rechargeable battery
Dimension H × W × D	4.25 × 2.4 × 0.98 in. (108 × 61 × 25 mm)
Weight	4.94 oz. (140 g) (without battery)

Specifications

Note

The LCD screen is manufactured using extremely high-precision technology. This ensures that 99.99% of the pixels work correctly. Some pixels (tiny dots of black, white, red, blue, or green) may appear on the LCD screen. These dots are a normal result of the manufacturing process and do not affect the recording.

Image Sensor	5 mega pixel
Operation Modes	<ul style="list-style-type: none"> • Movie Record • Picture Record • Voice Record • MP3 Player • Mass Storage Device
Lens	F3.2 (f = 7.2mm)
Focus Range	<ul style="list-style-type: none"> • Normal mode: 59 in. (150 cm) ~ infinite • Portrait mode: 35.4 in. ~ 78.7 in. (90 cm ~ 200 cm) • Macro mode: Center: 7.9 in. (20 cm)
Digital Zoom	8×
Shutter	Electronic
LCD monitor	3" TFT LCD
Storage Media	<ul style="list-style-type: none"> • Built-in 64 MB memory (part of memory is used for Firmware code) • SD/MMC card slot support

Installing the device driver software

To install the device driver software:

- 1 Insert the supplied mini CD into the CD drive on your computer. The *Autorun* window opens.
- 2 Click **Install Device Driver**, then follow the on-screen instructions to install the driver.

Accessing the User Guide

To access the User Guide:

- Insert the supplied mini CD into your computer and open the User Guide file.
Or

Visit the Insignia Web site at www.insignia-products.com and click on the Digital Camcorder link under Products.

Legal notices

FCC Part 15

This device complies with Part 15 of the FCC Rules. Operation of this product is subject to the following two conditions: (1) this device may not cause harmful interference, and (2) this device must accept any interference received, including interference that may cause undesired operation.

This equipment has been tested and found to comply within the limits for a class B digital device, pursuant to Part 15 of the FCC Rules. These limits are designed to provide reasonable protection against harmful interference in a residential installation. This equipment generates, uses, and can radiate radio frequency energy and, if not installed and used in accordance with the instructions, may cause harmful interference to radio communications. However, there is no guarantee that interference will not occur in a particular installation. If this equipment does cause harmful interference to radio or television reception, which can be determined by turning the equipment off and on, the user is encouraged to try to correct the interference by one or more of the following measures:

- Reorient or relocate the receiving antenna.
- Increase the separation between the equipment and receiver.
- Connect the equipment into an outlet on a circuit different from that to which the receiver is connected.
- Consult the dealer or an experienced technician for help.

FCC warning

Changes or modifications not expressly approved by the party responsible for compliance with the FCC Rules could void the user's authority to operate this equipment.

Canada ICES-003 statement

This Class B digital apparatus complies with Canadian ICES-003.

One-Year Limited Warranty

Insignia Products ("Insignia") warrants to you, the original purchaser of this new **NS-DCC5HB09** ("Product"), that the Product shall be free of defects in the original manufacture of the material or workmanship for a period of one (1) year from the date of your purchase of the Product ("Warranty Period"). This Product must be purchased from an authorized dealer of Insignia brand products and packaged with this warranty statement. This warranty does not cover refurbished Product. If you notify Insignia during the Warranty Period of a defect covered by this warranty that requires service, terms of this warranty apply.

How long does the coverage last?

The Warranty Period lasts for 1 year (365 days) from the date you purchased the Product. The purchase date is printed on the receipt you received with the Product.

What does this warranty cover?

During the Warranty Period, if the original manufacture of the material or workmanship of the Product is determined to be defective by an authorized Insignia repair center or store personnel, Insignia will (at its sole option): (1) repair the Product with new or rebuilt parts; or (2) replace the Product at no charge with new or rebuilt comparable products or parts. Products and parts replaced under this warranty become the property of Insignia and are not returned to you. If service of Products or parts are required after the Warranty Period expires, you must pay all labor and parts charges. This warranty lasts as long as you own your Insignia Product during the Warranty Period. Warranty coverage terminates if you sell or otherwise transfer the Product.

How to obtain warranty service?

If you purchased the Product at a retail store location, take your original receipt and the Product to the store you purchased it from. Make sure that you place the Product in its original packaging or packaging that provides the same amount of protection as the original packaging. If you purchased the Product from an online web site, mail your original receipt and the Product to the address listed on the web site. Make sure that you put the Product in its original packaging or packaging that provides the same amount of protection as the original packaging.

To obtain in-home warranty service for a television with a screen 25 inches or larger, call 1-888-BESTBUY. Call agents will diagnose and correct the issue over the phone or will have an Insignia-approved repair person dispatched to your home.

Where is the warranty valid?

This warranty is valid only to the original purchaser of the product in the United States, Canada, and Mexico.

What does the warranty not cover?

This warranty does not cover:

- Customer instruction
- Installation
- Set up adjustments
- Cosmetic damage
- Damage due to acts of God, such as lightning strikes
- Accident
- Misuse
- Abuse
- Negligence
- Commercial use
- Modification of any part of the Product, including the antenna

This warranty also does not cover:

- Damage due to incorrect operation or maintenance
- Connection to an incorrect voltage supply
- Attempted repair by anyone other than a facility authorized by Insignia to service the Product
- Products sold as is or with all faults
- Consumables, such as fuses or batteries
- Products where the factory applied serial number has been altered or removed

REPAIR REPLACEMENT AS PROVIDED UNDER THIS WARRANTY IS YOUR EXCLUSIVE REMEDY. INSIGNIA SHALL NOT BE LIABLE FOR ANY INCIDENTAL OR CONSEQUENTIAL DAMAGES FOR THE BREACH OF ANY EXPRESS OR IMPLIED WARRANTY ON THIS PRODUCT, INCLUDING, BUT NOT LIMITED TO, LOST DATA, LOSS OF USE OF YOUR PRODUCT, LOST BUSINESS OR LOST PROFITS. INSIGNIA PRODUCTS MAKES NO OTHER EXPRESS WARRANTIES WITH RESPECT TO THE PRODUCT, ALL EXPRESS AND IMPLIED WARRANTIES FOR THE PRODUCT, INCLUDING, BUT NOT LIMITED TO, ANY IMPLIED WARRANTIES OF AND CONDITIONS OF MERCHANTABILITY AND FITNESS FOR A PARTICULAR PURPOSE, ARE LIMITED IN DURATION TO THE WARRANTY PERIOD SET FORTH ABOVE AND NO WARRANTIES, WHETHER EXPRESS OR IMPLIED, WILL APPLY AFTER THE WARRANTY PERIOD. SOME STATES, PROVINCES AND JURISDICTIONS DO NOT ALLOW LIMITATIONS ON HOW LONG AN IMPLIED WARRANTY LASTS, SO THE ABOVE LIMITATION MAY NOT APPLY TO YOU. THIS WARRANTY GIVES YOU SPECIFIC LEGAL RIGHTS, AND YOU MAY ALSO HAVE OTHER RIGHTS, WHICH VARY FROM STATE TO STATE OR PROVINCE TO PROVINCE.

Contact Insignia:

For customer service please call 1-877-467-4289
www.insignia-products.com

Distributed by Best Buy Purchasing, LLC
7601 Penn Avenue South, Richfield, Minnesota, U.S.A.
55423-3645

© 2008 Best Buy Enterprise Services, Inc.

All rights reserved. INSIGNIA is a trademark of Best Buy Enterprise Services, Inc. Registered in some countries. All other products and brand names are trademarks of their respective owners.

INSIGNIA™

www.insignia-products.com (877) 467-4289

Distributed by Best Buy Purchasing, LLC
7601 Penn Avenue South, Richfield, MN USA 55423-3645
© 2008 Best Buy Enterprise Services, Inc.

All rights reserved. INSIGNIA is a trademark of Best Buy Enterprise Services, Inc. Registered in some countries.
All other products and brand names are trademarks of their respective owners.